

水槽 KE Gun Metal



水槽

代码: 2157 856



细节

表面处理 PVD

质地 拉丝 Foster

边型和安装方式 台下

材料 AISI 304 不锈钢

染色 Gun Metal

底座 80 cm

尺寸 750x440 mm

标准配件 固定钩, 垫圈, 下水器, 溢水口和虹吸管, 纸板盒包装

龙头孔 无定位孔

安装孔 [View technical data sheet](#)

下水器 否

宽 75 cm

盆内尺寸 710x400mm

单槽/双槽 单槽

下水组件 3,5" 下水器

特点

枪黑色 Gun
Metal表面处理是通过采用称为PVD（物理气相沉积）的物理工艺处理钢而获得的，该工艺将贵金属颗粒沉积在表面上，从而具有独特着色，并改善了钢的机械性能，从而更耐冲击和耐刮擦。

高厚度 1mm厚的钢。相当大的厚度，保证了最大的坚固性和耐用性。

3.5" 下水器提篮 Foster®水槽均配备了3.5"下水器，有可防止固体颗粒流入下水器的实用篮式塞。3.5"下水器允许使用Foster®碎渣机，可与所有型号兼容。

溢水口 溢水口是Foster水槽上的一项安全措施，可以防止疏忽时水的溢出。方形溢水解决方案，具有简约的方形，更加美观大方。

小倒角 具有现代设计和更大容量的方形碗，具有最小的美观性和极高的实用性。

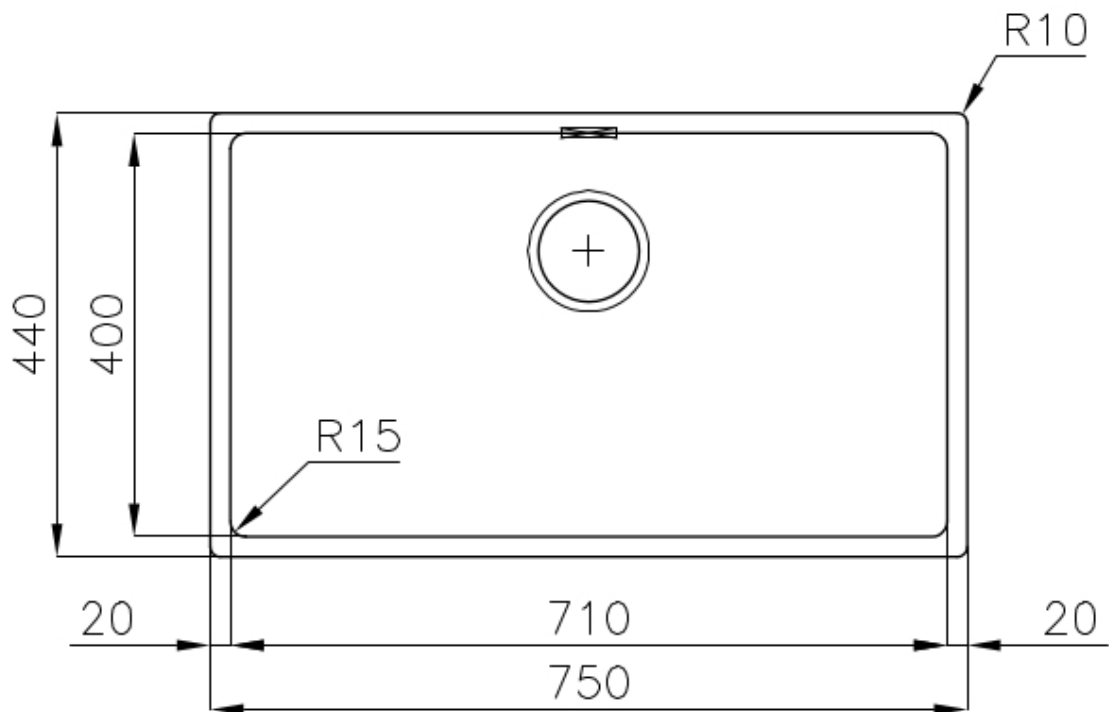
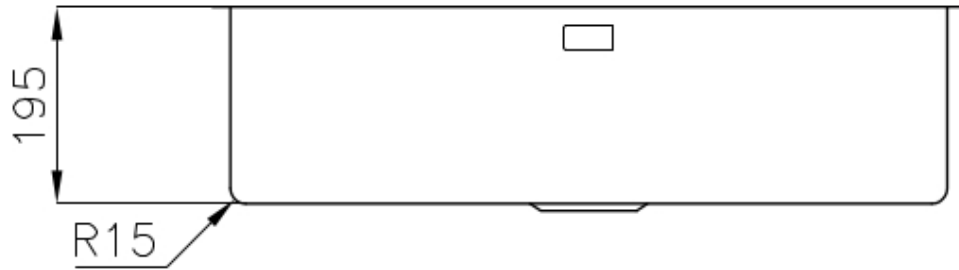



Cut out size
Dimensioni per foratura top



OPTIONAL ACCESSORIES



HPDE Twin 砧板
8644 101



HPDE 砧板
8657 001



不锈钢爪篱
8154 000



不锈钢篮
8612 000



不锈钢背板
8100 154

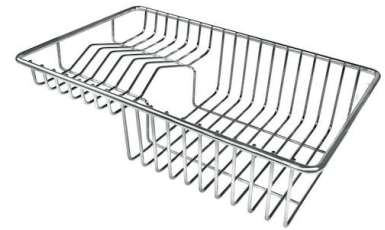

不锈钢背板
8100 303
* 仅与附件结合使用 8644 101



玻璃砧板
8631 300



白托盘
8153 100



白篮
8612 100



不锈钢背板
8100 201

RECOMMENDED PAIRINGS



龙头 **Omega Gun Metal**
8497 856



龙头 **Skin Gun Metal**
8424 856

OPTIONAL AUTOMATIC WASTE FITTINGS



自动下水器 枪黑色
8407 110



自动下水器 枪黑色 **Space**
8407 120